



KeyShield SSO

Václav Šamša

CEO, Inventor &

Project leader

TDP Ltd

vsamsa@tdp.cz



//// TDP

KeyShield SSO :

SSO, SLO, RELOGIN

Windows, MacOSX, Linux, iOS, Android

Browser independent SSO

SAML 2.0 a JWT IdP

CAS, SPRING, NAM, Shibboleth integrate

Radius Accounting client & server

Walk Away Security

2FA with HW Token



KeyShield SSO ve vysokém školství :

autentizace - WCM, PROXY, FW

integrace - jednoduchá pro aplikace, které sami vyvíjíte

LDAP – více různých adresářů najednou

odezva – až 10.000 požadavků za vteřinu

Active Directory – řeší výkonové omezení s LDAP – čte LDAP, ověřuje proti Kerberos

BYOD – jednoduchá instalace a provoz



Oslovte nás:

Ověřovací instalace pro neomezený počet uživatelů resp. zařízení

Podpora pro vývojáře v ceně

Office365 SSO chytře a bez Azure

Principal ID per integrovaný systém

Abstrakce rozdílů mezi různými adresáři

Násobné zvýšení rychlosti autentizace

SLEVA až 90% při nákupu i pro studenty



Optimized Java Engine

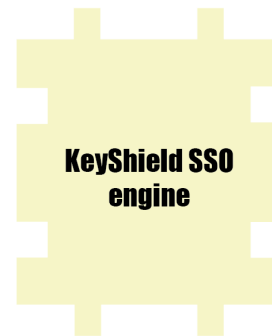

Comfort and useful Admin Console



LDAP browser for easy troubleshooting

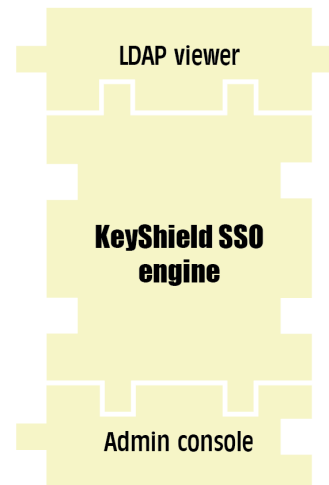

Log debug level setup and online view

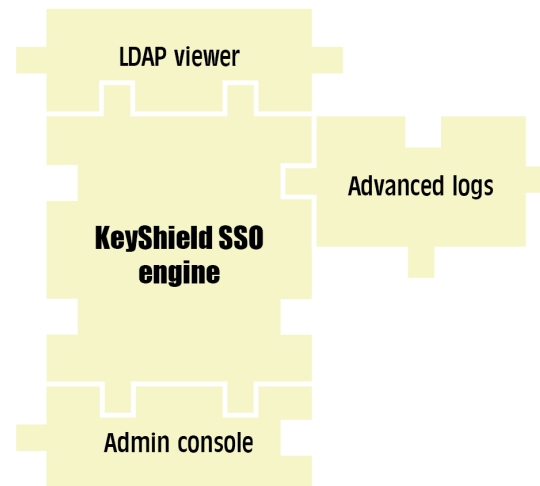

Yellow message → all client platforms

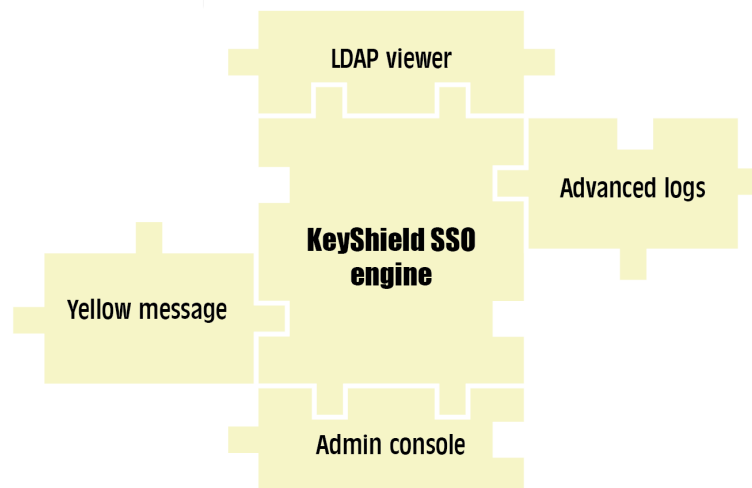

Embedded Apache DS

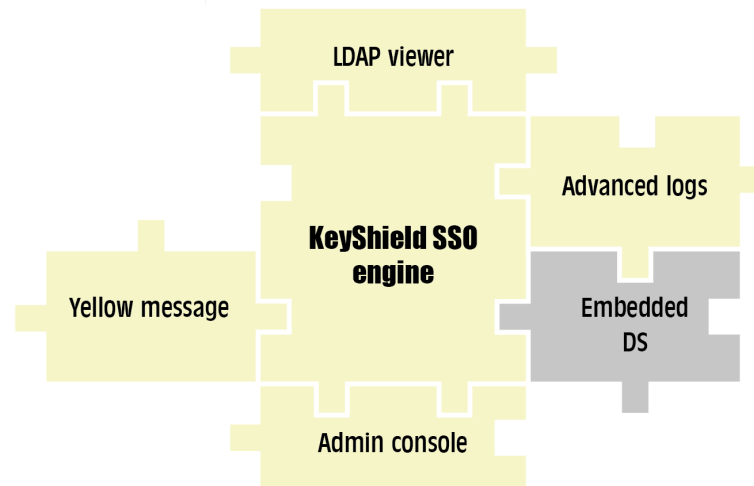

SSL, AppKey, Win client installation

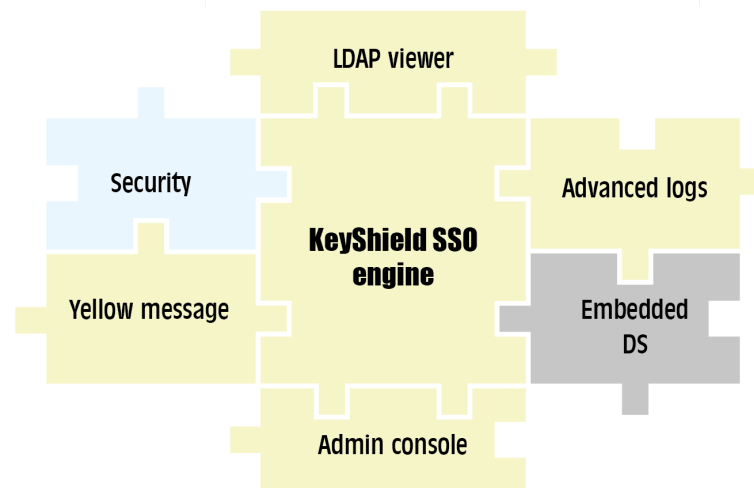

As many as you need – eDIR, AD, LDAP

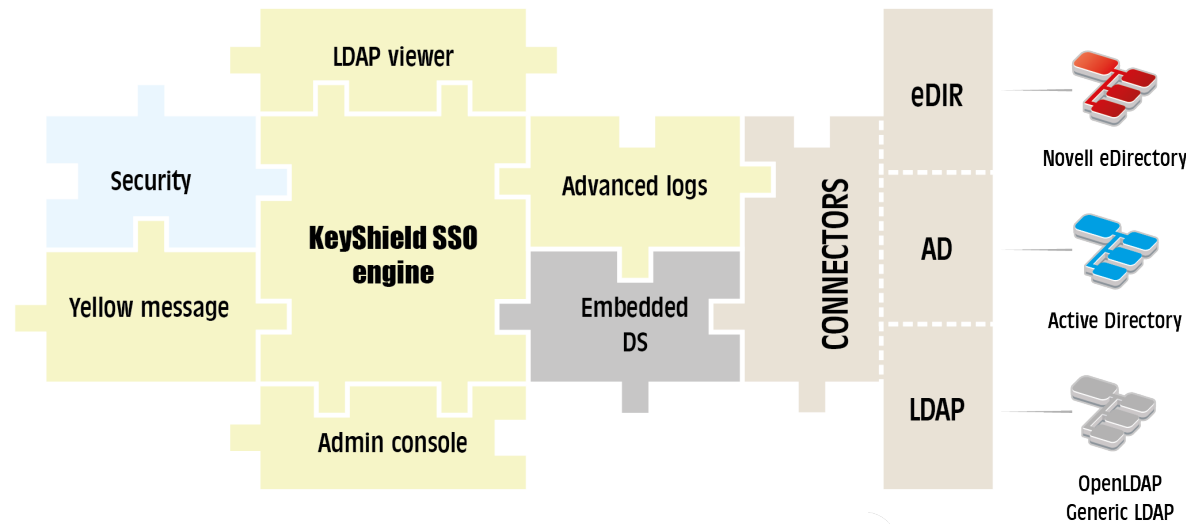

Win, Mac, Linux, iOS, Android, BB

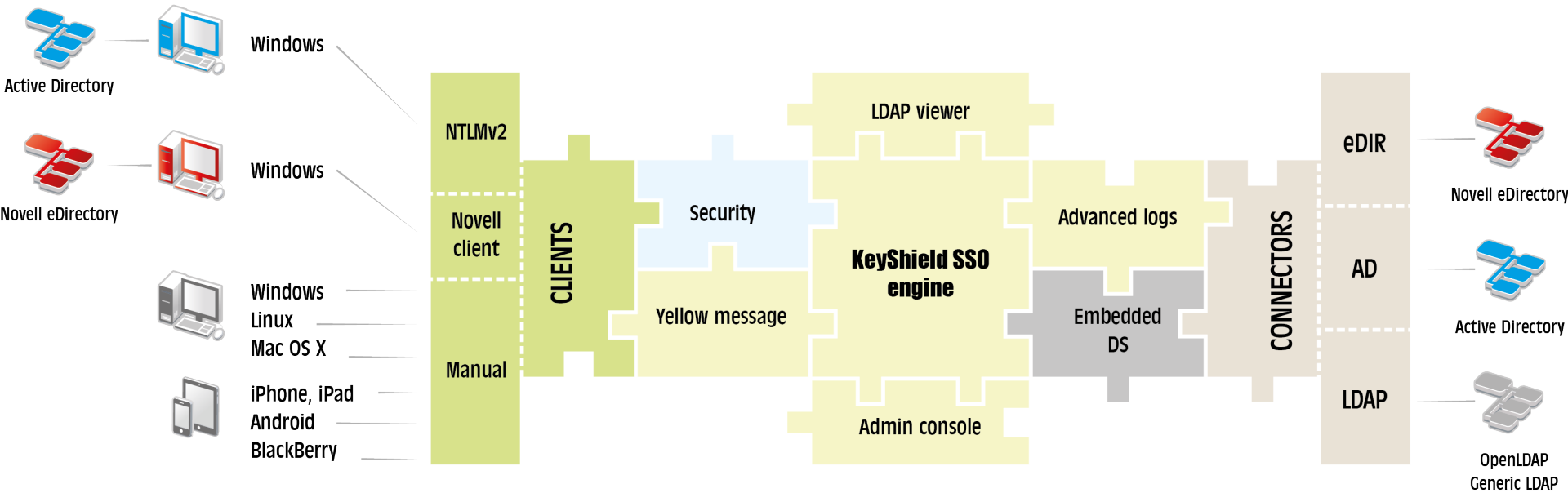

REST - fast, secure, easy to implement

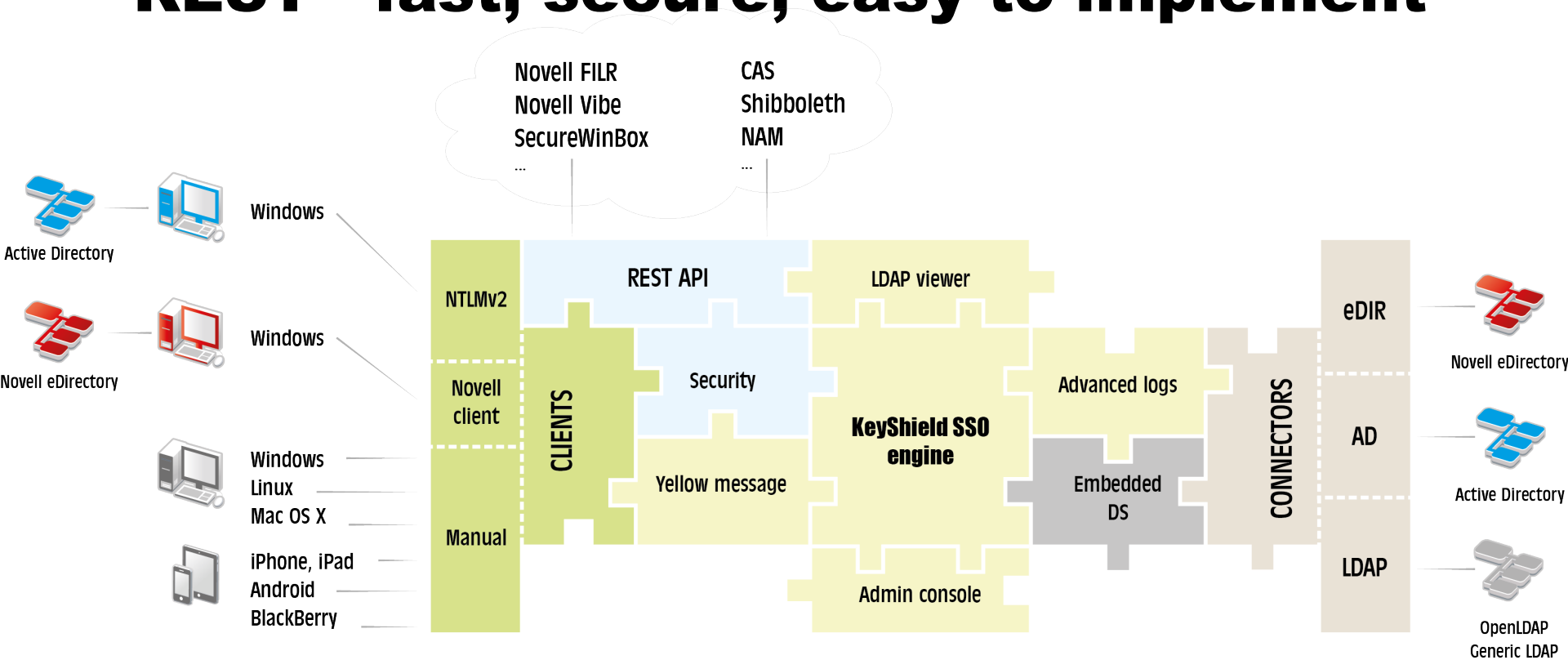

SAML 2.0 multi instance

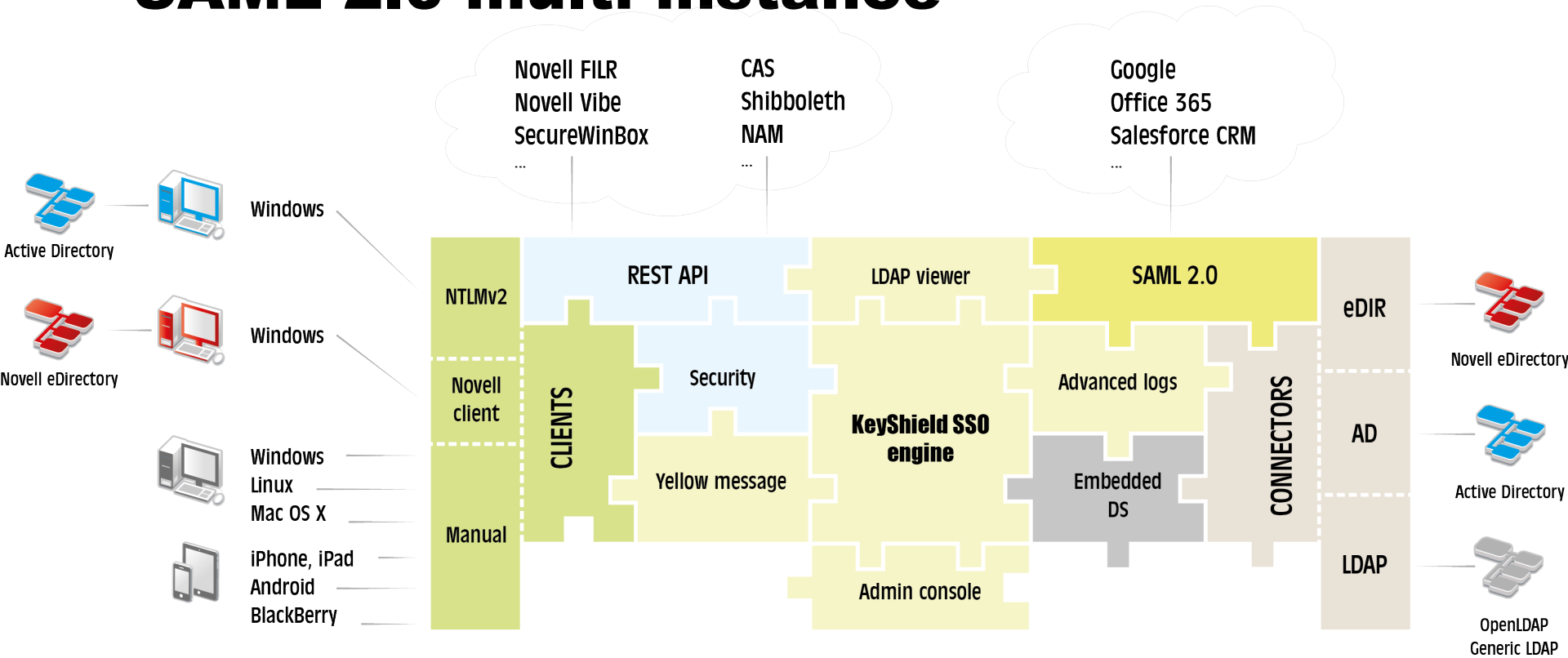

eDirectory specific – user net address

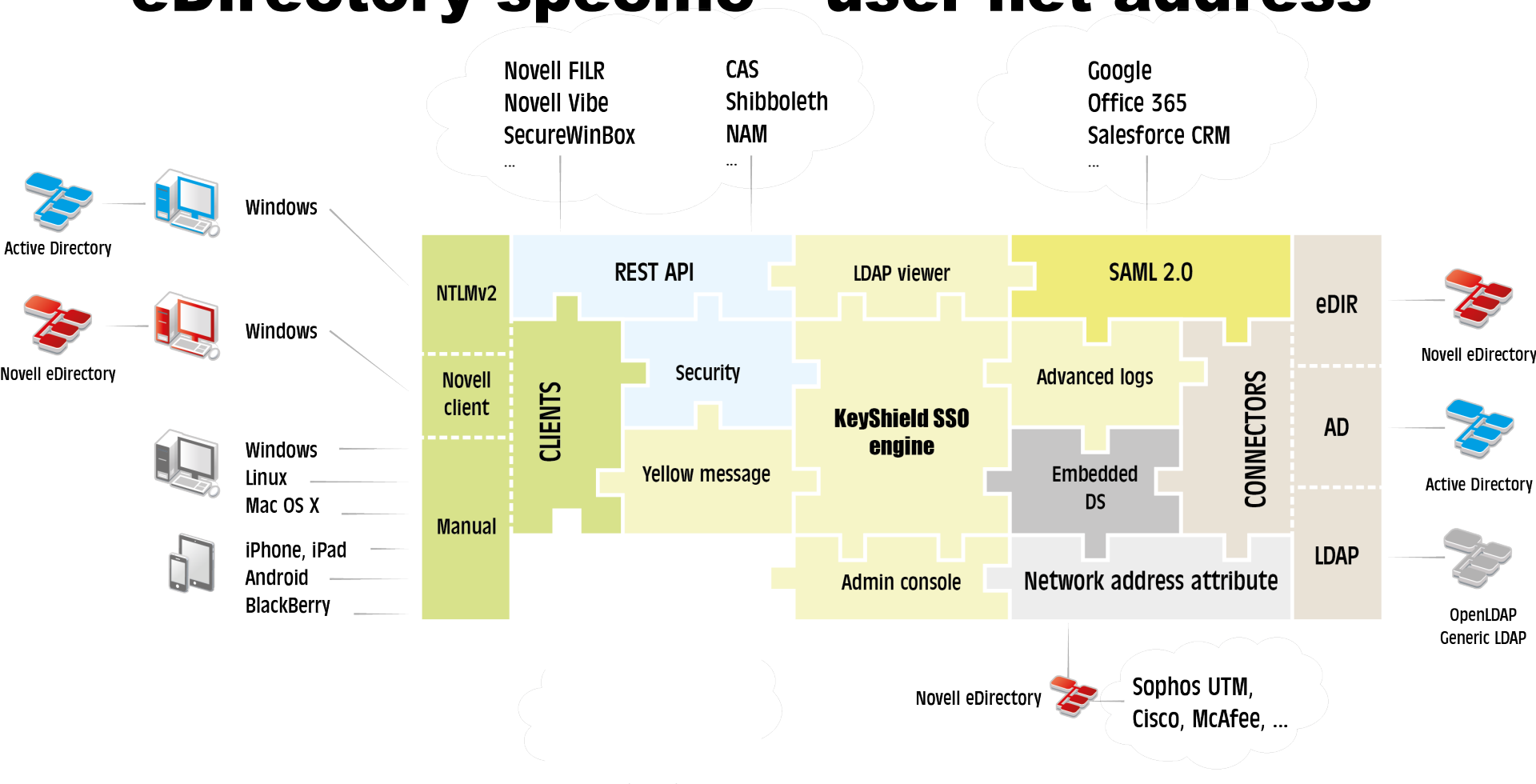

Server provided Radius Accounting

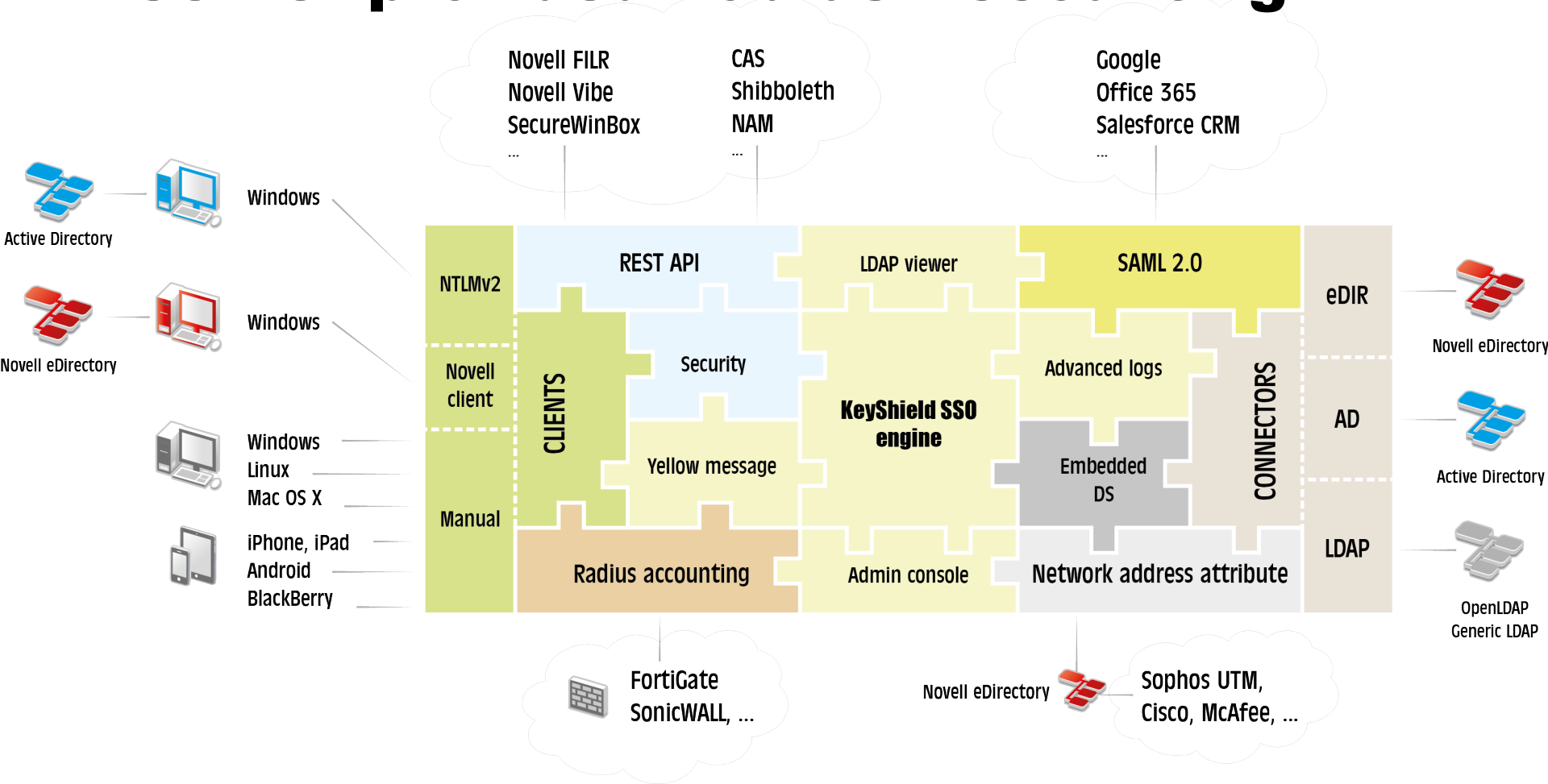

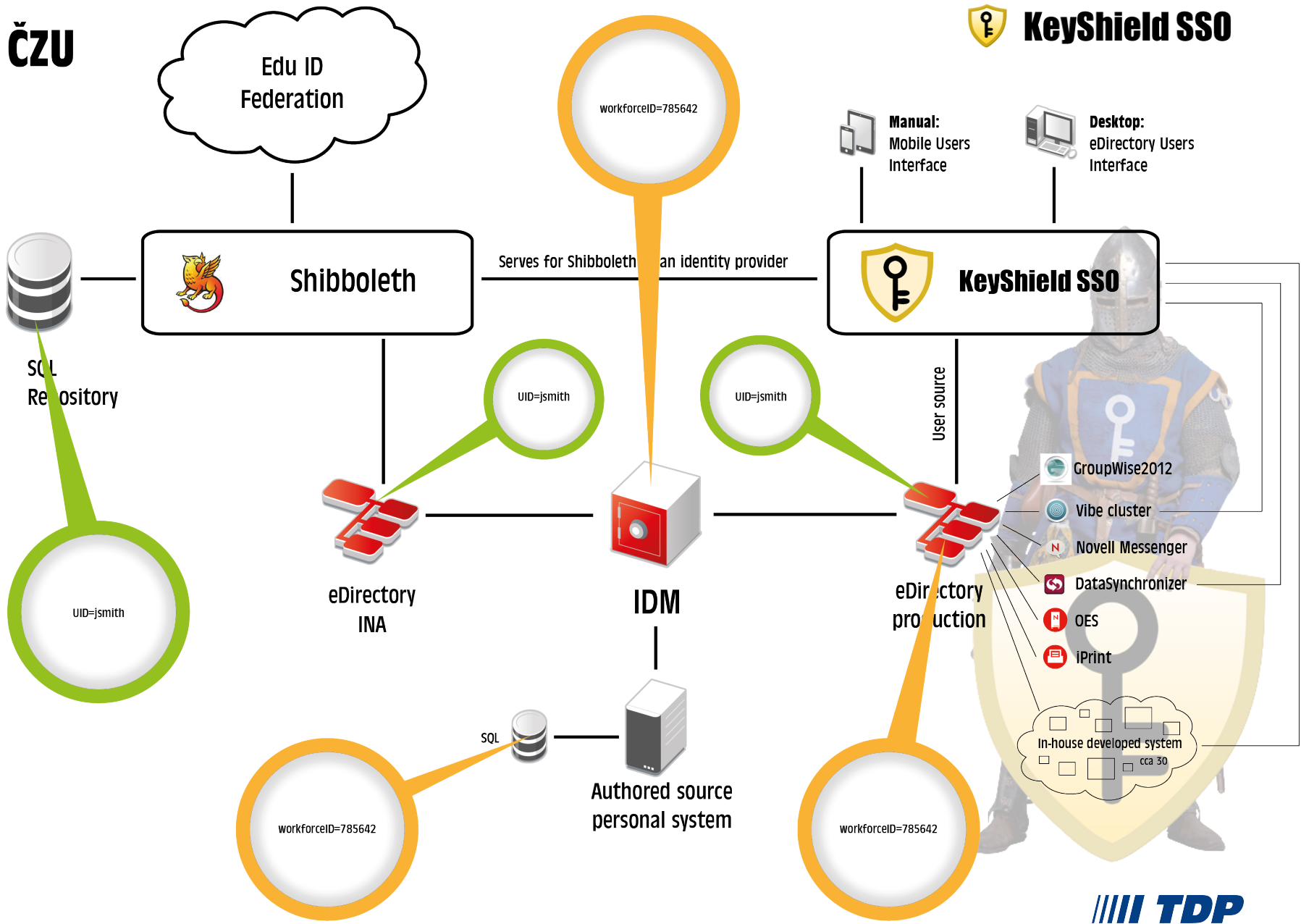

KeyShield SSO

Q/A

vsamsa@tdp.cz

